

FADINI
l'apricancello
Made in Italy

I

LIBRETTO DI ISTRUZIONI
Elpro•10 PLUS
MONOFASE - TRIFASE PER CANCELLI
SCORREVOLI E AUTOMAZIONI CON FINECORSO

- FUNZIONE PASSO PASSO
- UOMO PRESENTE
- APERTURA PEDONALE
- SPIA DI SEGNALAZIONE DELLO STATO DELL'AUTOMAZIONE
- POSSIBILITA' DI ESCLUDERE LAMPEGGIANTE IN PAUSA
- LUCE DI CORTESIA TEMPORIZZATA
- FUNZIONE OROLOGIO

pag. 1,2,3,4

GB

INSTRUCTIONS
Elpro•10 PLUS
SINGLE- AND THREE-PHASE FOR SLIDING GATES
AND AUTOMATIONS FITTED WITH LIMIT SWITCHES

- STEP BY STEP
- HOLD-ON SWITCHED (DEADMAN) CONTROL
- PEDESTRIAN OPENING
- GATE STATUS INDICATION
- FLASHING LAMP DURING DWELL TIME. MADE SWITCHED ABLE
- ADJUSTABLE COURTESY LIGHT TIME
- TIME CLOCK OPTION

page 1,5,6,7

F

NOTICES D'INSTRUCTION
Elpro•10 PLUS
MONOPHASE - TRIPHASE POUR PORTAILS
COULISSANTS ET AUTOMATISMES AVEC FINS DE COURSE

- FONCTION PAS-PAS
- HOMME MORT
- OUVERTURE PIETON
- VOYANTS A DIODE DE SIGNALISATION DE L'ETAT DE L'AUTOMATISATION
- POSSIBILITE D'ETEINDRE LA LAMPE DE SIGNALISATION EN PAUSE
- LAMPE D'ECLAIRAGE TEMPORISEE
- FONCTION HORLOGE

page 1,8,9,10

D

ANLEITUNG
Elpro•10 PLUS
EINPHASIGE - DREIPHASIGE FÜR SCHIEBETORANTRIEBE
UND AUTOMATIONEN MIT ENDSCHALTER

- SCHRITT-IMPULS-FUNKTION
- TOTMANN-BEDIENUNG
- GEHTÜRFUNKTION
- AUTOMATION-STATUS ANZEIGELAMPE
- MÖGLICHE AUSSCHALTUNG DER BLINKLEUCHTE BEI DER PAUSE
- EINSTELBARES BEDIENUNGSLICHT
- UHR-FUNKTION

Seite 1,11,12,13

E

FOLLETO DE INSTRUCCIONES
Elpro•10 PLUS
MONOFASICO - TRIFASICO PARA VERJAS
DESIZANTES Y AUTOMATISMOS CON TOPES DE RECORRIDO

- FUNCIONAMIENTO PASO A PASO
- HOMBRE PRESENTE
- ABERTURA PARA PASO DE PEATONES
- LÁMPARA TESTIGO QUE SEÑALA EL ESTADO DEL AUTOMATISMO
- POSIBILIDAD DE EXCLUIR EL DESTELLADOR EN PAUSA
- LUZ AUXILIAR TEMPORIZADA
- FUNCIÓN RELOJ

pág. 1,14,15,16

NL

HANDLEIDING
Elpro•10 PLUS
EENFASE - DRIEFASE VOOR SCHUIFHEKKEN EN
AUTOMATISERINGEN MET EINDSCHAKELAAR

- STAP-VOOR-STAP FUNCTIE
- DODEMANSFUNCTIE
- VOETGANGERSDOORGANG
- SIGNALERINGSLAMP AUTOMATISERINGSSTATUS
- MOGELIJKHEID UITSCHAKELING KNIPPERLICHT BIJ PAUZE
- INSTELBARE INDICATIELAMP
- KLOKFUNCTIE

pag. 1,17,18,19

Dis. N. 4135



Via Mantova, 177/A - C.P. 126 - 37053 Cerea (Verona) Italy - Tel. +39 0442 330422 r.a.
Fax +39 0442 331054 - e-mail: info@fadini.net - www.fadini.net



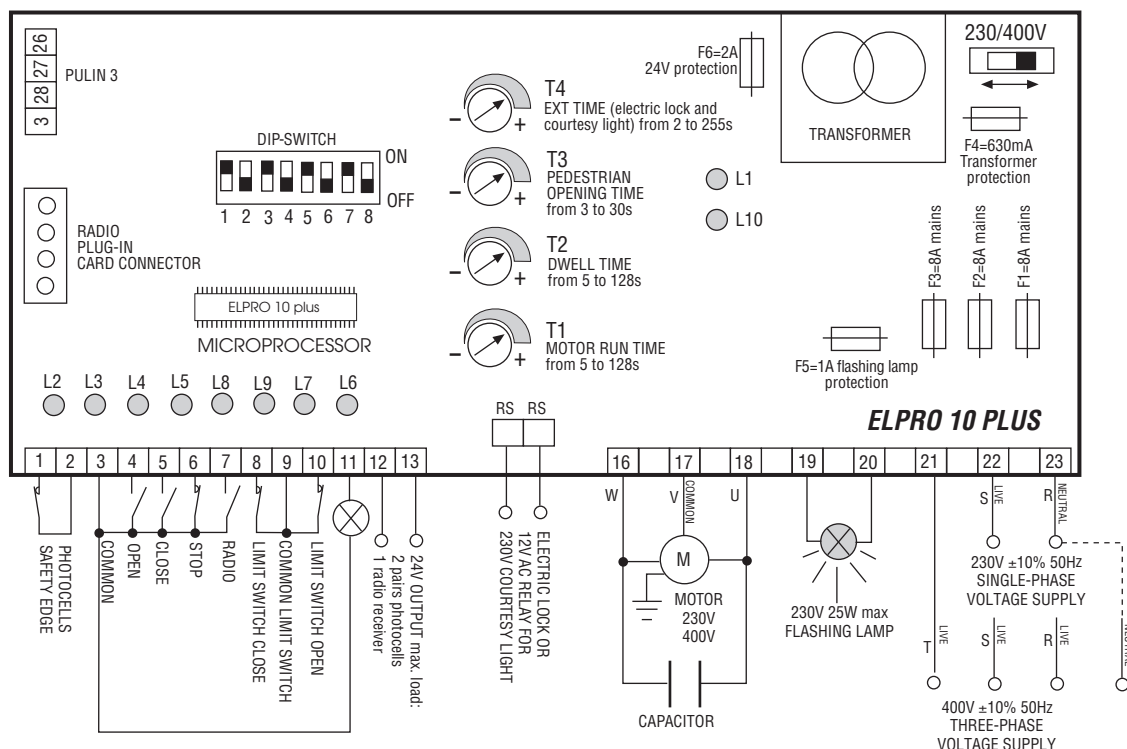

General description: the electronic control panel Elpro 10 Plus, new generation, is designed to operate sliding gates. Power supply is 230/400V single-phase and three-phase. Built in full compliance with 2006/95/CE Low Voltage and 2004/108/CE - 92/31/CEE Electro-Magnetic Compatibility Regulations. Fitting operations are recommended by a qualified technician in conformity to the existing safety standards. The manufacturing company declines any responsibility for incorrect handling and application; also, it reserves the right to change or update the control panel any time. **Failure to follow installation regulations may result into serious damage to property and persons.**



PLEASE NOTE:

- The control panel must be installed in a sheltered, dry place, inside the box provided with it.
 - Make sure that the power supply to the electronic programmer is 230V $\pm 10\%$ or 400V $\pm 10\%$
 - Make sure that the power supply to the Electric Motor is 230V $\pm 10\%$ or 400V $\pm 10\%$
 - For distances of over 50 metres we recommend using electric cables with bigger sections.
 - Fit the mains to the control panel with a 0.03A high performance circuit breaker.
 - Use 1.5 mm² section wires for voltage supply, electric motor and flashing lamp. Maximum recommended distance 50 m. Use 1 mm² section wires for limit switches, photocells, push-buttons/key-switch and accessories.
 - Bridge terminals 1 and 2 if no photocells are required.
 - Bridge terminals 3 and 6 if no key- or push-button switches are required.
- N.W. To fit extra accessories such as lights, CCTV etc. use only solid state relays to prevent damages to the microprocessor.

Dip-Switch:

- 1= ON. Photocells. Stop while opening
- 2= ON. Radio. No reversing while opening
- 3= ON. Automatic closing
- 4= ON. Preflashing activated
- 5= ON. Radio. Step by step. Stop in between
- 6= ON. Deadman Control (Dip 4=OFF and Dip 3=OFF)
- 7= ON. No lamp on during dwell time
- 8= OFF. Blank

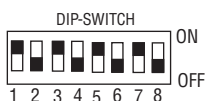

In case of failure of the panel:

- Make sure that the power supply to the electronic programmer is 230V $\pm 10\%$ or 400V $\pm 10\%$
- Make sure that the power supply to the Electric Motor is 230V $\pm 10\%$ or 400V $\pm 10\%$
- Check fuses
- Check photocells if contacts are normally closed
- Check all NC contacts
- Check that no voltage drop has occurred from the control panel to the electric motor

Led Status Indication:

- L1= 230V 50Hz power supply. A light
- L2= Photocells, if obstructed light goes off
- L3= Open. A light whenever an Open pulse is given
- L4= Close. A light whenever a Close pulse is given
- L5= Stop. It goes off on pulsing Stop
- L6= Radio. It goes on by pressing a transmitter button
- L7= Gate Status; it flashes on gate moving
- L8= Limit switch Close; off when gate is closed
- L9= Limit switch Open; off when gate is open
- L10= It stays on for a time equal to the time set on T4 Trimmer

LOW VOLTAGE ELECTRICAL CONNECTIONS

Photocells and Safety Edge:



DIP-SWITCH 1:

- ON: Photocells stop gate while opening, reverse it on closing once obstacle is removed
- 1 OFF: Photocells do not stop gate while opening, reverse it on closing in case of an obstacle

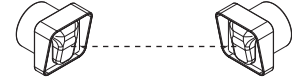

Button switch:

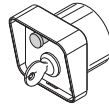
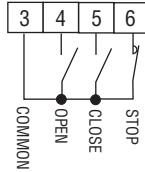

Limit switch:

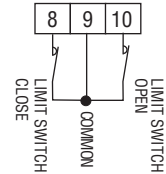

Radio Contact:

- Open/Close (Standard)
- Travel reversing on pulsing
- Step by step

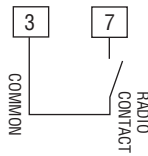

DIP-SWITCH 2 and 5 (NEVER set BOTH of them to ON at the same time):

- ON: Gate is not reversed while opening
- 2 OFF: Any pulse reverses the gate

- ON: Step by step. Stop in between
- 5 OFF: Standard operating mode

Push Button Switch Pulin 3:

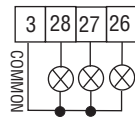

Led to indicate status of Open - Stop - Close switches

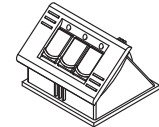
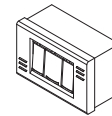

24V 3W Indication Light:

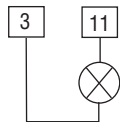

- Light **ON** = Open gate
- Light **OFF** = Closed gate
- Flashing (**fast**) **0.5s** = Closing gate
- Flashing (**normally**) **1s** = Opening gate
- Flashing (**slowly**) **2s** = gate is stopped

Courtesy light:

Connect a 24VAC Modular Relay (T4 Trimmer Time from 2s to 255s) to operate a 230V lamp



T4
- TIME EXT (Electric lock and courtesy light) from 2 to 255s



Electric lock:

Set the T4 Trimmer Time to the lowest value
The electric lock is excited for 2 seconds

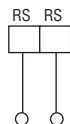

T4

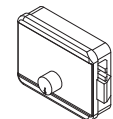

ELECTRICAL POWER CONNECTIONS

Single- (230V) and Three-phase (400V) Motors:

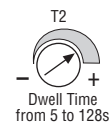
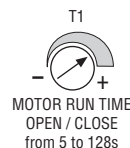
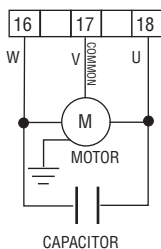

Flashing lamp:

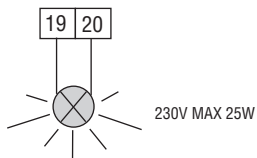

DIP-SWITCH 4 and 7:

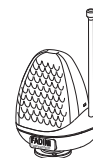
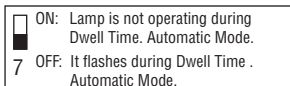
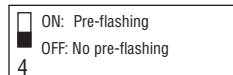

Power supply:

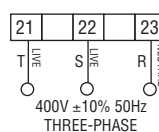
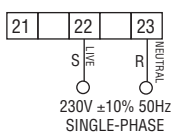

OPERATING MODES

Automatic / Semiautomatic:

Automatic Operation: any pulse opens the gate, the gate stays open as long as the Dwell time expires as set by T2 trimmer, then it closes automatically, no pulsing is required.

Semi-automatic Operation: any pulse opens the gate that stays open. A second pulse to Close is required for the gate to close.

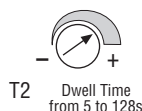

DIP-SWITCH 3

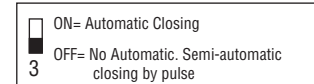

Pedestrian Opening:

Trimmer T3 to the lowest disactivates Pedestrian Opening
From 3 to 30s it can be activated by any pulse (eg. by remote control) superior to 2s

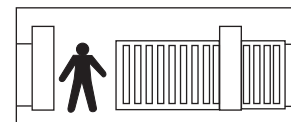

Hold on switched (Deadman) control:

Open and Close operations are achieved "by holding a switch on" (no relay self-holding is involved) therefore a physical attendance is required to keep the gate opening or closing until either the button or key is released.

DIP-SWITCH 6

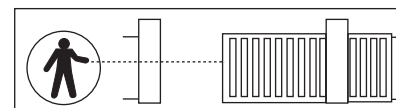
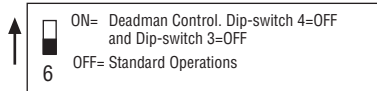

Remote Controlled Operations Excluded during Dwell Time on Automatic Mode:

With this setting it is not possible to operate the gate by remote control during the dwell time on automatic mode.
DIP-SWITCH 2=ON, 3=ON and 5=ON

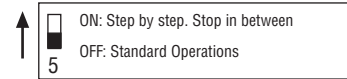
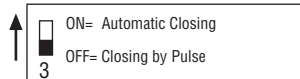
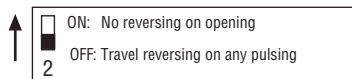

Time clock installation:

How it works: Set the clock to the required time. On the pre-set time the gate is automatically opened and held open. Any further pulsing (even by remote control) is not accepted by the system until the time pre-set by the clock has expired. On expiring and after the pre-set dwell time the gate is closed automatically.
T3 trimmer on to zero, Dip-Switch 3=ON.



DIP-SWITCH No.3=ON Automatic Closing

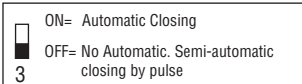

External Time Clock

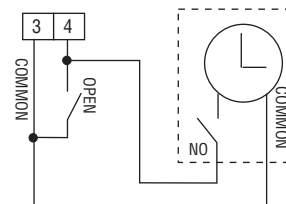

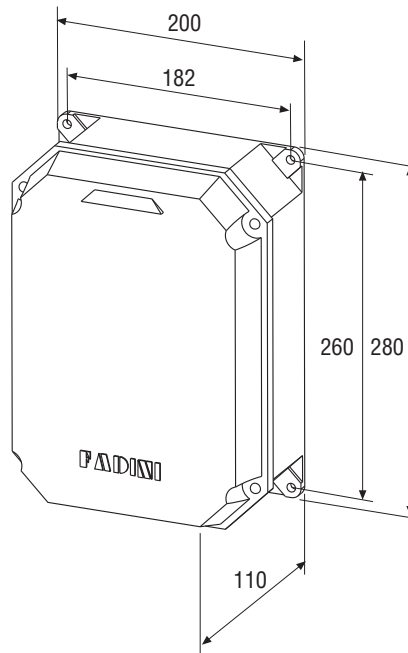

- I** - Prima dell'installazione da parte di personale tecnico qualificato, si consiglia di prendere visione del Libretto Normative di Sicurezza che la Meccanica Fadini mette a disposizione.
- GB** - Please note that installation must be carried out by qualified technicians following Meccanica Fadini's Safety Norms Manual.
- F** - L'installation doit être effectuée par un technicien qualifié suivant le manuel des Normes de Sécurité de Meccanica Fadini.
- D** - Vor der Montage durch einen Fachmann, wird es empfohlen die Anleitung zur Sicherheitsnormen, die Meccanica Fadini zur Verfügung stellt, nachzulesen.
- E** - Antes de la instalación por el personal técnico calificado, se recomienda leer detenidamente el Folleto de la Reglamentación de Seguridad que la empresa Meccanica Fadini pone a su disposición.
- NL** - Voordat de installatie door gekwalificeerd technisch personeel wordt uitgevoerd, wordt geadviseerd om het boekje met veiligheidsvoorschriften dat Meccanica Fadini ter beschikking stelt door te lezen.



I Direttiva **2003/108/CE**
Smaltimento dei materiali
elettrici ed elettronici

**VIETATO GETTARE NEI RIFIUTI
MATERIALI NOCIVI PER L'AMBIENTE**

GB **2003/108/CE** Directive
for waste electrical and
electronic equipments

**DISPOSE OF PROPERLY
ENVIRONMENT-NOXIOUS MATERIALS**



**Via Mantova, 177/A - C.P. 126 - 37053 Cerea (Verona) Italy - Tel. +39 0442 330422 r.a. - Fax +39 0442 331054
e-mail: info@fadini.net - www.fadini.net**